



The modern aluminium lantern roof that helps keep heat in



## A BETTER LANTERN ROOF

The purpose designed Stratus aluminium lantern roof system is discreet yet stylish. Stratus allows light to flood into your home's interior, the ideal modern lantern solution, coupling sleek contemporary looks with truly outstanding performance.

Designed from the ground up around an innovative thermally broken system, it provides excellent thermal performance - keeping cool in the summer and warm in the winter - while delivering the architectural refinement you'd expect of a high end aluminium lantern system.

Whether you are building a new kitchen-diner extension or replacing an existing lantern roof, Stratus will help redefine your home, creating light and airy spaces for you to enjoy.



---

Create Light, Airy Spaces



Contemporary design

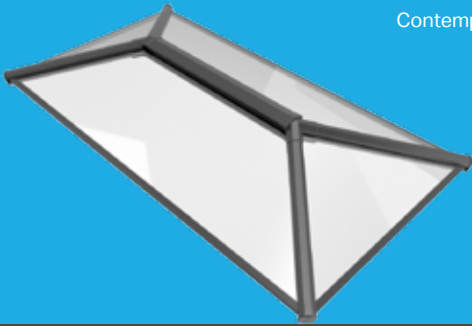

Anthracite Grey  
RAL 7016

2 way design

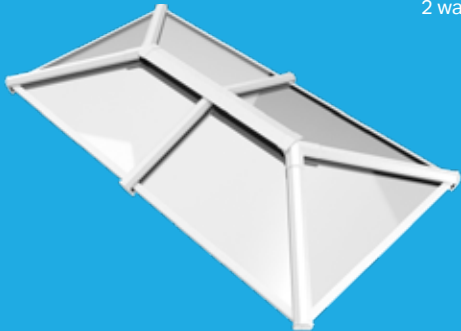

Crisp White  
RAL 9016

3 way design

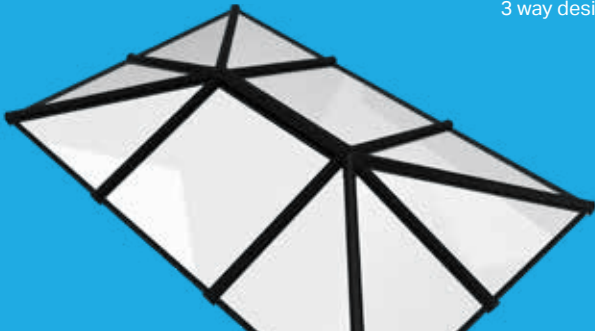

Black  
RAL 9005 Black 60%



Any RAL  
Colour available

## DESIGN AND COLOUR OPTIONS

Available in 2-way, 3-way, 4-way or contemporary designs, with sizes up to 3m x 6m, this high end, high performance lantern roof is ideal for modern living. Stratus is ideal for fresh, bright interiors that want to be opened up and bathed in light.

Stratus comes in a choice colour finishes: black, grey and white as standard or any RAL Colour.

For the ultimate in minimalism, the innovative contemporary style supports the ridge solely by the hip rafters, for an ultra slim, clean and modern look.

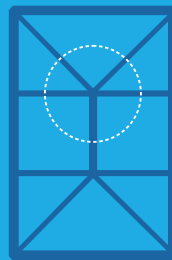

**2 way design**  
Max dimensions  
1500mm x 6000mm



**3 way design**  
Max dimensions  
3000mm x 6000mm

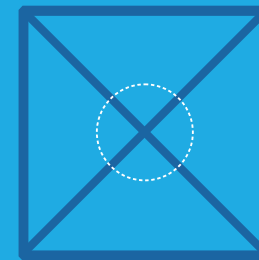

**4 way design**  
Max dimensions  
2000mm x 2000mm

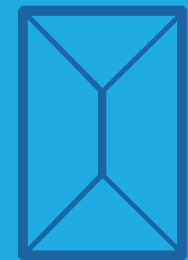

**Contemporary design**  
Max dimensions  
1500mm x 3000mm

Versatile Configurations



" We now have a multifunctional room we can use all year round for cooking, entertaining and relaxing. The two Stratus lantern roofs have made a huge difference to the space."

---





Thermal break technology ensures that Stratus is warm in the winter and cool in the summer. Every element of the lantern has an ultra-low conductive element that separates the inner and outer aluminium skin, helping keep heat transfer down, and your heating bills low.

# INNOVATIVE FULLY THERMALLY BROKEN LANTERN ROOF

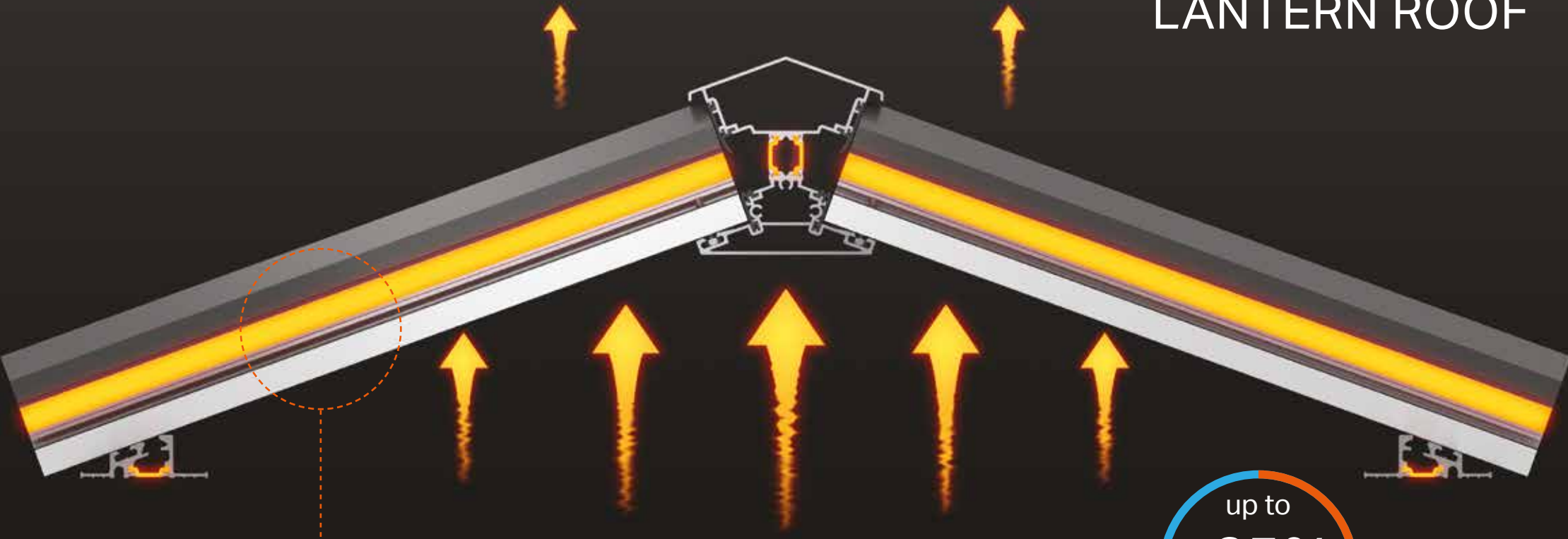

533x

Polyamide nylon, glass composite thermal breaks are 533 times more thermally efficient than aluminium!

up to  
**+65%**

more thermally efficient than  
conventional aluminium roof systems

## SIMPLY BUILT BETTER

Every element of the Stratus Thermal Lantern Roof has been designed to be exceptional. From the low profile 20° pitch that allows us to use purpose designed cappings that keep sightlines to a minimum - and your view of the sky maximised - to the discreet black finish of our perimeter beam, that ensures if you view the lantern from above all you'll see is glass and a discreet shadow line.

Stratus is high-quality British engineering at its best.

---

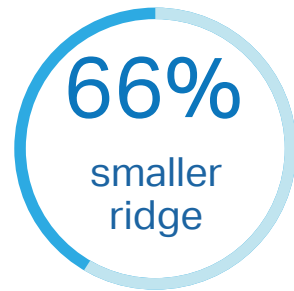

than conventional aluminium roof systems for stunning aesthetics

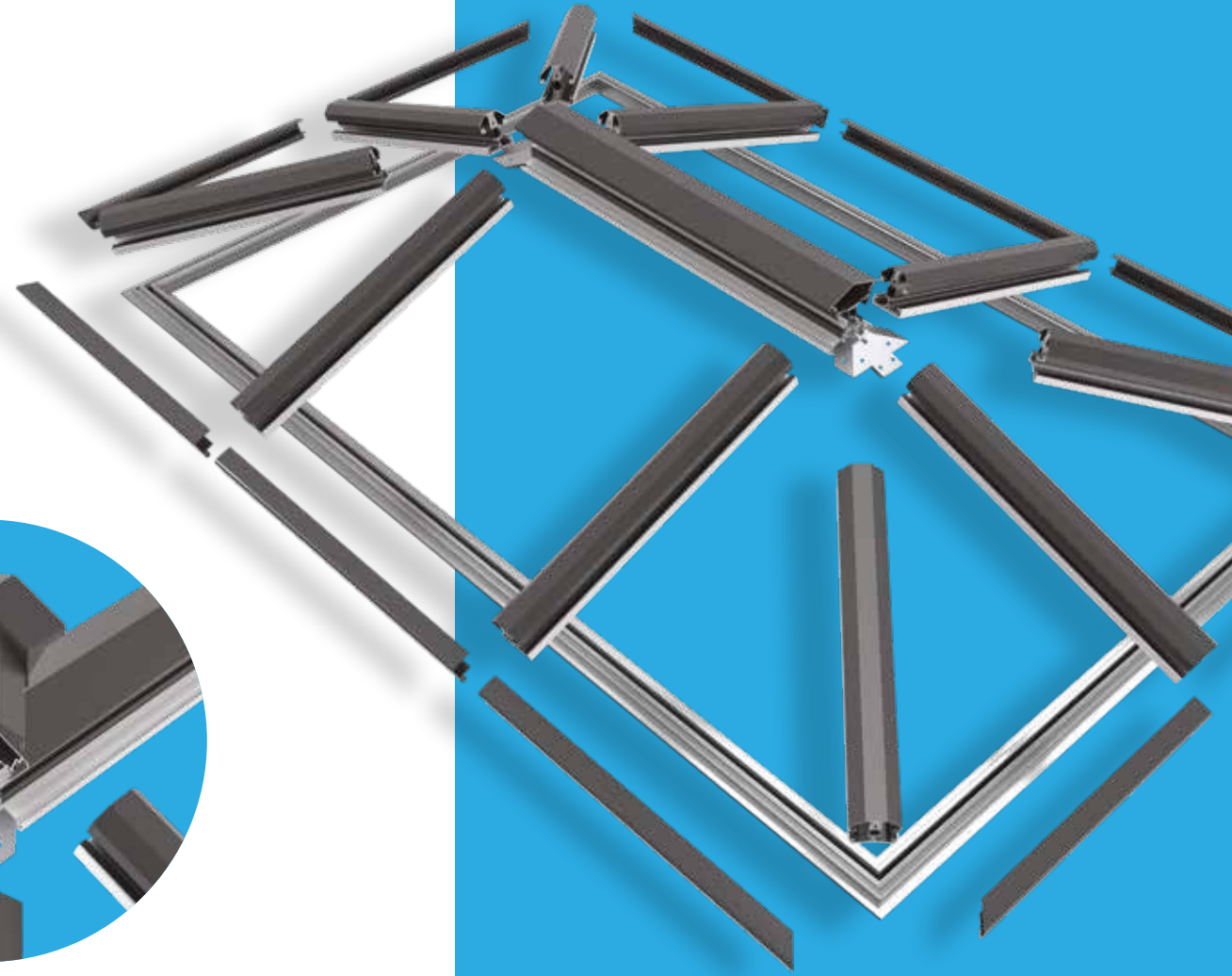
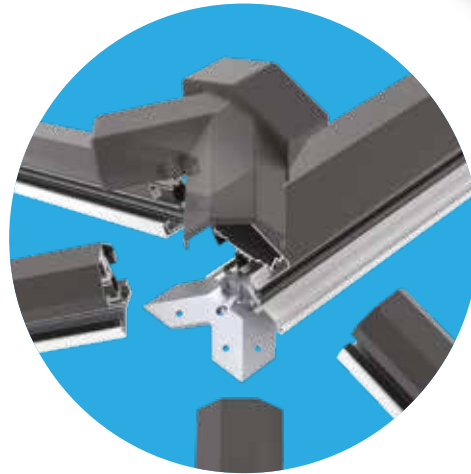

Precision Engineered Quality



S002, Stratus Retail Brochures V5 FEB 2022



**stratus**  
thermal lantern roof

THE EVOLUTION  
OF THE ALUMINIUM  
LANTERN ROOF



UK designed and  
manufactured